

# Vogelhaus “Schweden“

mit Silo + Ständer

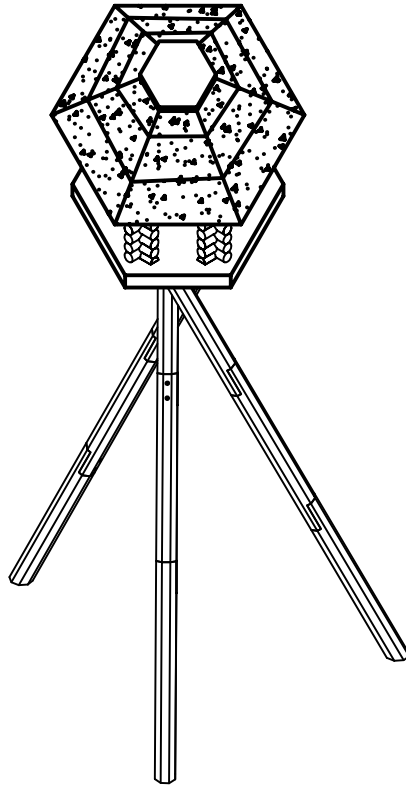

**Artikel-Nr.: 2510**

**Article-No.: 2510**

## **DE** Montageanleitung

## **EN** Assembly Instruction

Lieber Kundin, lieber Kunde!  
Wir wollen für Sie immer 100% geben und Ihnen langlebige, hochwertige Produkte in höchster Qualität liefern.  
Wir hoffen, Ihnen dadurch eine 5 ☆☆☆☆☆ Bewertung wert zu sein!  
Sollte dennoch etwas nicht zu Ihrer Zufriedenheit gewesen sein, nehmen Sie bitte Kontakt zu Ihrem Verkäufer auf.

Bitte beachten Sie auch die folgenden Pflegehinweise, um Ihr Produkt rundum zu schützen:

Viele unserer Artikel sind bereits mit einer Holzschutzlasur auf Wasserbasis vorbehandelt. Für eine lange Lebensdauer empfehlen wir Ihnen, das Produkt ein weiteres Mal zu lasieren.







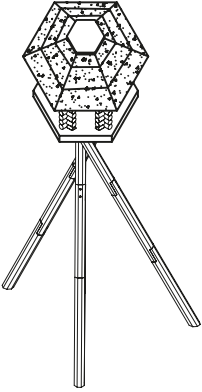

Ihr HABAU Team

Dear Customer!  
We always want to give 100 percent to provide you with products in outstanding quality and hope we are worth a 5 ☆☆☆☆☆ rating to you!  
If there is anything that you are not satisfied with, please contact your retailer service.

Please also regard the following protection info before setting up your product:

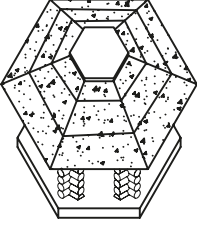
A lot of our products are prepared with a wood protection stain on water basis. For a long life expectancy we suggest another staining.

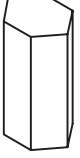
Your HABAU Team

		3		3 Stück pieces	
		4		3 Stück pieces	
		5		3 Stück pieces	
1		1 Stück piece	6	 Leim	1 Stück piece
			A	 3.5*35mm	12 Stück pieces
2		1 Stück piece	B	 3.5*50mm	3 Stück pieces

